

kapal

S T O N E

Manufacturing Quality Products





The Kapal Difference

Kapal Industries is a family owned business with over 10 years providing south Texas area with manufacturing and installation services of cabinets and countertops for commercial, multifamily, and hospitality markets, as well we serve other states without installation. Over the years Kapal has built a strong reputation with satisfied customers around the Texas. Our clients have come to expect these high level of product and service and come back to us because they trust we will deliver.

We believe that style is more than just aesthetics, so we work hard to turn your vision into a reality. In 2017 Kapal setup the most sophisticated state-of-the-art facility to fabricate stone countertops in granite, quartz, and solid surface right next to our cabinetry plant. There is an existence total of 140,000 square feet manufacturing facilities to better serve our customers.

Whether your style is contemporary or classic, we believe you are the driving force of your own definitive creative vision. We are proud to be one of the first turnkey manufacturer that provide cabinets and countertops with a short lead time, installing the same day with our own skilled team, to offer you the confidence in knowing that your project is being handled with a superior level of professional and craftsmanship from conception to completion.

We install our own countertops from Mid to South Texas, and ship to all USA states and other countries.



Table of Contents

Multifamily Apartments	Page 03
Hotels	Page 04
Clinics	Page 05
Cut to Size	Page 06
Granite & Quartz	Page 07
Standard Sinks	Page 08
Standard Sinks Ceramic	Page 09
3CM Quartz Conference & Dining Tables	Page 10
3CM Quartz Conference & Dining Tables Sizes	Pages 11 & 12
Granite & Quartz Products	Page 13
Kapal Stone Capacity	Page 14
Tips on Caring for Granite & Quartz Countertops	Page 15

Vision

Be the best in the industry by continuously setting and meeting new goals.

Mission

With research and preparation, we plan to deliver high quality products and supplies to our customers, working diligently to meet their needs and desires.

Core Values

Treat customers with uttermost respect, honesty and humbleness, making their happiness our priority.



Multifamily Apartments



Kapal Company Group

Transform any space with new countertops and sinks, we pay close attention to every detail on our products to offer you exceptional quality and style.

Direct Importers

direct importers of natural stone with a large selection of granite, quartz and marble.

Turnkey Company

We are able to supply, manufacture, and installed your project complete and ready to use.

Complete Project Study

Before any job is done we study each project to deliver high quality and service with short lead times and accurate results.

Cut Precise

99% Of every project is cut precise to get perfect results and avoid dust in job site. Allowing you to make use of your facilities faster.

Last Large Projects Developed

		Location:	Units:
1	Abacus Alamo Ranch Apartments	San Antonio, Tx	320
2	Saint Mary Apartments	Austin, Tx	240
3	Santal Luxury Apartments	Austin, Tx	212
4	Ambrosio Subdivision	Pflugerville, Tx	370
5	Jackson Place Apartments	Pharr, Tx	288

Hotels



Last Hotels Projects Developed

		Location:	Units:
1	Residence Inn	Corpus Christi, Tx	143
2	Townplace	Austin, Tx	110
3	Courtyard	SPI, Tx	205
4	Element Hotel	Katy, Tx	143
5	Holiday Inn	San Marcos,	80
6	Holiday Inn Express & Suites	Brenham, Tx	80

Clinics



Kapal's state of the art facility offers the capacity to handle large projects and versatility to take on those custom pieces that set your project apart. At kapal we like to go the extra mile to ensure that your project is made with the best materials and that everything is installed correctly.

Last Clinics Projects Developed

		Location:
1	Dr. Alfredo V. Gonzalez Medical Facility	Pharr, Tx
2	Vela Saenz Family Dentistry	Edinburg, Tx
3	Growing Smiles Children's Dental Center	McAllen, Tx
4	Little Heroes Pediatric Dentistry	San Juan, Tx
5	Pulmonary & Sleep Center of the Valley	McAllen, Tx
6	McAllen Oncology P. A.	McAllen, Tx

*“Great people doing high quality and innovative products.
Excellent service.”*

Marco Antonio Castilla
Google Review

Cut to Size One Kitchen at a Time

As a full service company, we can provide to the fabricator cutting, edging and polishing of **Quartz, granite, dekton** and **marble** at its finest in a large state-of-the-art factory. Reducing lead time and in job site dust.

How does it work?

1

- Select your material
- Granite
 - Quartz
 - Dekton
 - Marble
 - Sinks

2

Your fabricator of preference should measure the space of desire countertop to obtain shop drawings of the desired countertop.

3

Once we receive the shop drawings with all the measurements and specifications, the manufacturing process begins.

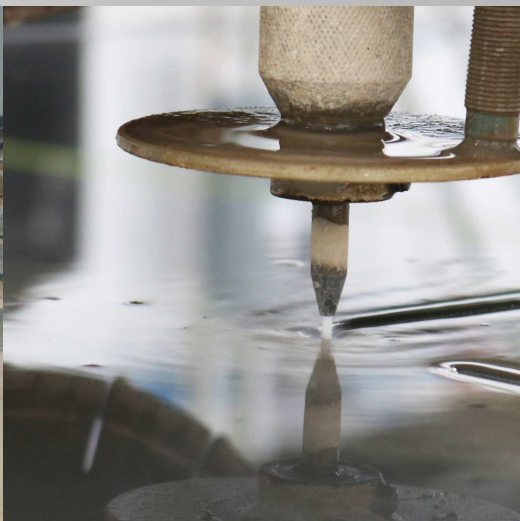
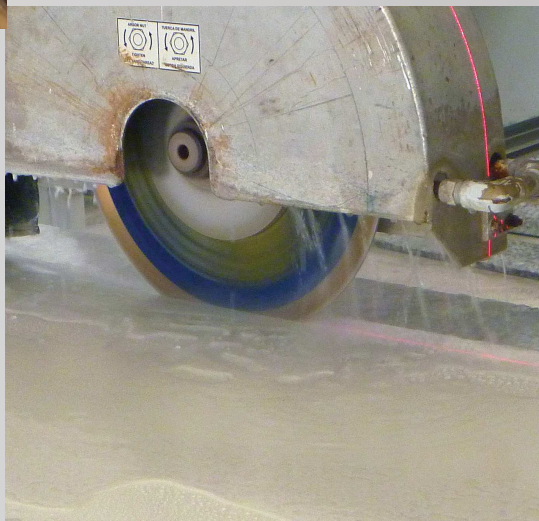

4

There is a turnaround of 2-5 days to complete small project. After shop drawings

5

Once the countertop is ready, your fabricator can come and pick up the final finished product.

6

Your fabricator is ready to start a hazard free installation of a cut to size countertop.

***We offer delivery**

*For large projects please contact a sales representative

Lead Time:

- 2-5 days if material in stock

Granite & Quartz Usually In Stock

Comodity Granite Colors: 2cm & 3cm



Santa Cecilia



Ornamental



Fiorito



White Dallas



Venetian Ice



Venetian Gold



Caledonia



Ubatuba



Kashmir White

Quartz Entry Level I Colors: 2cm

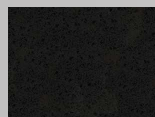
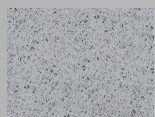

Eternal collection: 3cm Usually In Stock from SILESTONE



Calacatta Gold



Statuario



Pearl Jasmine



Serena

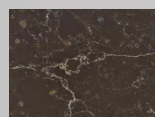

Emperador

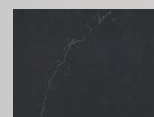

Charcoal Soapstone



Marquina

Exotic Granite Only Available at 3cm:



Cloudy White



Steel Gray



Sequoia



New River White



Blue Fire Leathered

and more...



CAMBRIA



*Colors are for reference only.

*The colors above are normally in stock, we carry a large variety of other colors.

956-464-3311

07

Standard Sinks Usually In Stock

Kitchen Handmade Sinks 18" GA & 16" GA

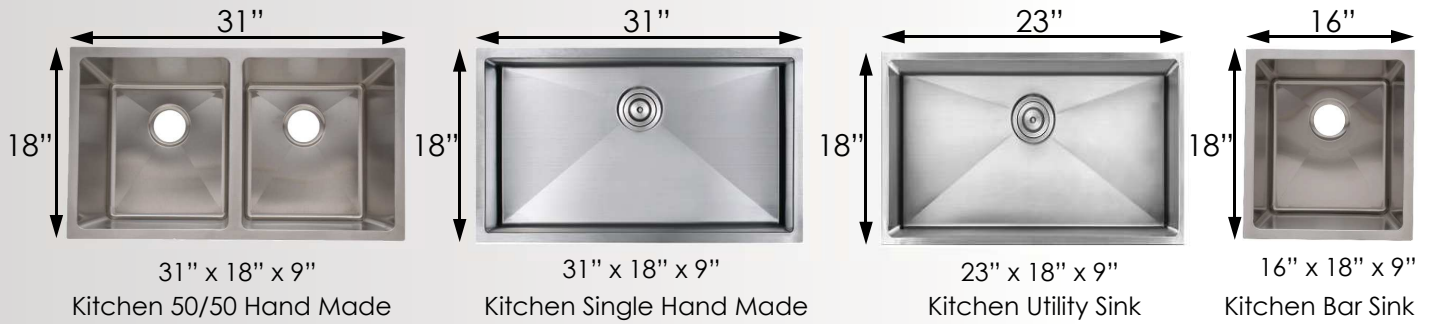

Kitchen Standard Sinks 18" GA

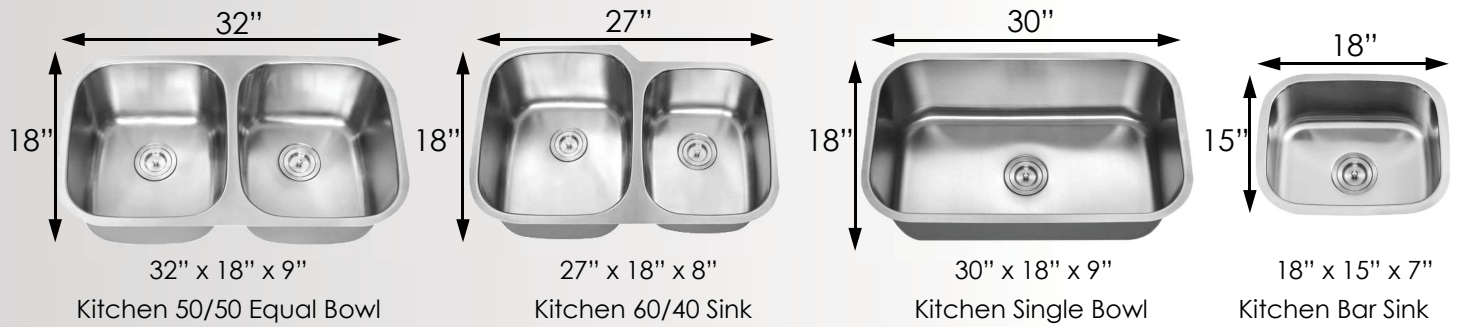

Top Mount Single Sinks 18" GA



*available by request only

Under-mount Sink Installation

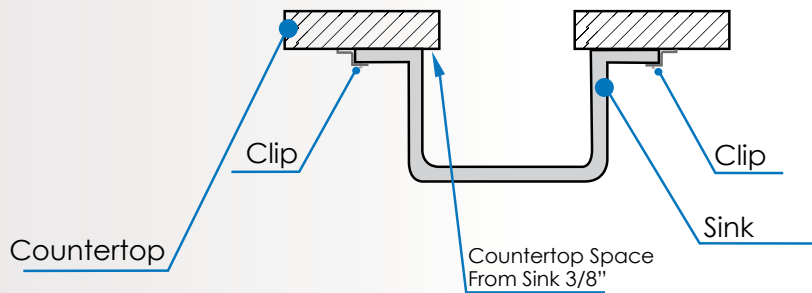

6 clips per sink

Sink Measurements are Approximate

*Dimensions are for reference, not for cutting purposes
 *Photo only as a reference, final product may vary

Standard Sinks Usually In Stock

Ceramics Bath Sinks

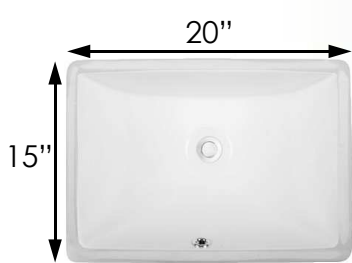

20" x 15" x 7"

Ceramic Rectangular Large



18" x 13" x 7"

Rectangular Easy Wall Small

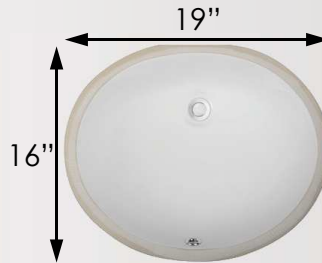

19" x 16" x 8"

Ceramic Large Oval

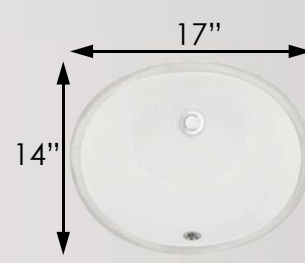

17" x 14" x 7"

Ceramic Small Oval

Ceramic Drop In Bath Sink



20" x 16" x 8"

Under-mount ceramic sink

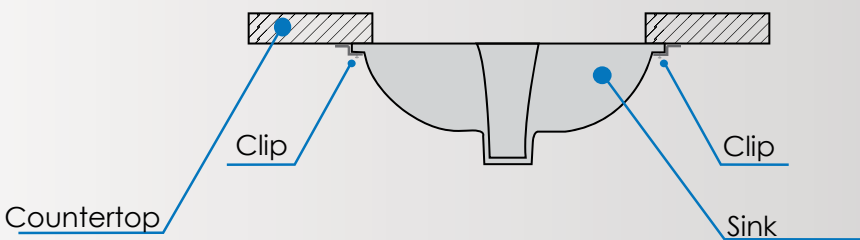

4 clips per sink

3CM Quartz Conference & Dining Tables



Table Top shape:







 Venetian A <input type="checkbox"/>	 Venetian B <input type="checkbox"/>
 Venetian C <input type="checkbox"/>	 Florence A <input type="checkbox"/>
 Florence B <input type="checkbox"/>	 Florence C <input type="checkbox"/>
 Milan <input type="checkbox"/>	

Table Bases:

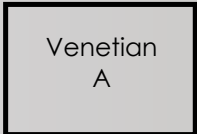
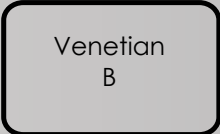

Wood



Metal



Quartz

Profiles:

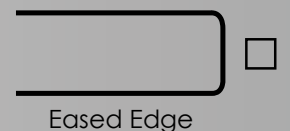

Eased Edge



Bevel



Platner
*Pending

3CM Quartz Conference & Dining Tables Sizes

VENETIAN

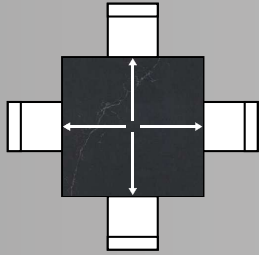

Size: 36" x 36"
Seats: 4

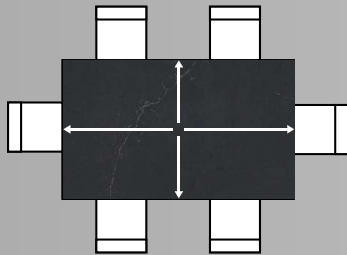

Size: 59" x 36"
Seats: 6

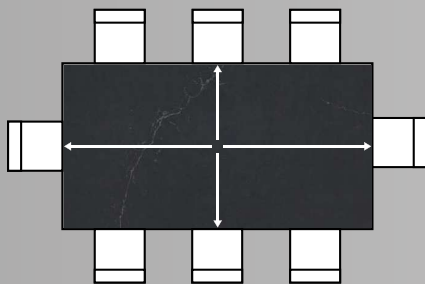

Size: 79" x 43"
Seats: 8

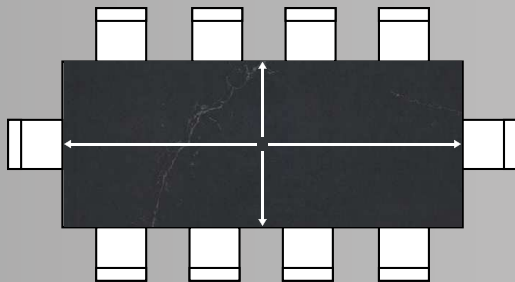

Size: 102" x 43"
Seats: 10

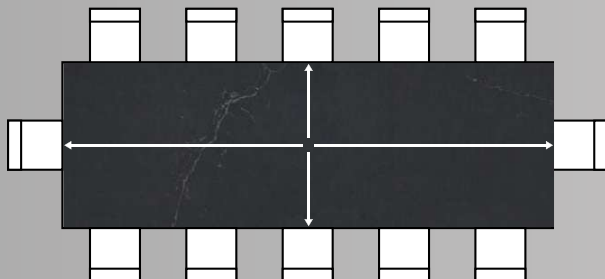

Size: 125" x 43"
Seats: 12

MILAN







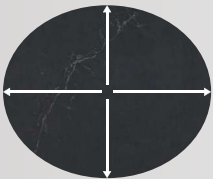
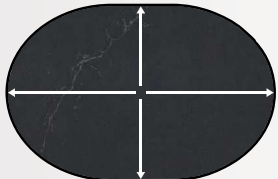

*available customize your own size
956-464-3311

Standard dimensions

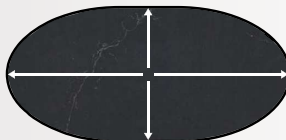
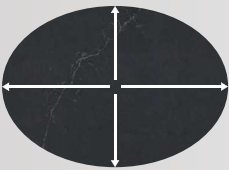
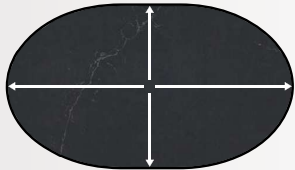
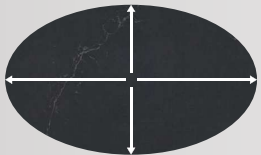
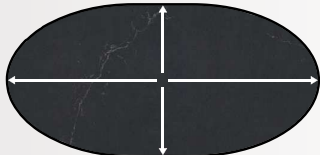
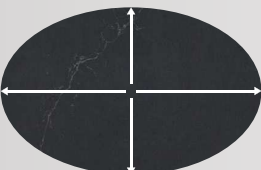
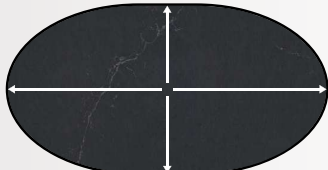
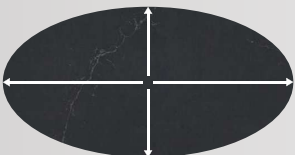
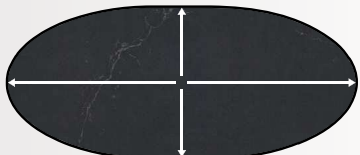
Seats: 8-15

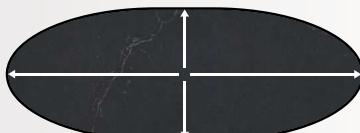
FLORENCE

	Size: 60" x 72"		Size: 60" x 92"
	Size: 46" x 77"		Size: 46" x 97"
	Size: 56" x 78"		Size: 56" x 98"
	Size: 52" x 87"		Size: 52" x 107"
	Size: 58" x 90"		Size: 58" x 110"
	Size: 52" x 100"		Size: 52" x 120"
	Size: 45" x 102"		Size: 45" x 122"
	Size: 42" x 106"		Size: 42" x 126"

Granite & Quartz Products

Introducing the new line of granite & quartz products Kapal Stone has to offer, elegant, durable, and functional. Granite & quartz Products for the office, household and kitchen.



Products we offer:

- Plantpots
- Cutting boards
- Patio tables
- Business cards holders
- Window sills
- Sculpture base
- Coat rack



Plant Capacity

Kapal Stone operates in an advanced manufacturing facility in the state of Texas. Your product uses our world-class equipment and facilities to the maximum advantage to ensure that your product meets the highest standards of quality, precision, and performance.

Capabilities

Kapal Stone's capabilities are constantly growing to meet the continuously changing demands of the marketplace. We offer a truly broad range of services from simple component manufacture and assembly to full project capability, from concept to completion, including manufacture, inventory stocking and supply.

Production installed capacity:

- 5,000 sq ft per week



Benefits



Shorter Lead Times

We are a company based in the US allowing us to provide faster service with great quality.



All In One Company

Offering the manufacture, assembly, material supply, delivery and installation services for all of our projects to better serve our customers.



Competitive Prices

We manufacture our own products and optimize the materials and production times to offer better pricings



High Quality Products

Finding the best quality materials and manufacturing with the latest technology machines out in the market is key to us, to provide you with superior results.



Innovation & Design

We are always looking for the latest tendencies and most practical products for the day to day, to help you optimize your spaces.



Safety & Quality Control

One of our goals is to always provide high quality products that are safe and correctly assembled for customer use.

Tips on Caring for Granite & Quartz Countertops

When it comes to cleaning your kitchen counters, one method does not fit all. Discover how to clean countertops and keep them in top shape.

Granite

- Clean them daily with a damp cloth and a few drops of dishwashing soap. Rinse the countertop with clean water and then dry it with a soft cloth. There's no need to use chemicals or specialty cleaners every day.
- Use a granite sealer every 12 months. Sealing keeps stains and germs from settling into pores and hairlines cracks that are inherent with any natural stone.
- avoid using vinegar, lemon juice, harsh cleaners, or abrasive materials, which can cause damage.

Quartz

- The best thing for cleaning quartz countertops is mild dish soap, water, and a soft non-abrasive cloth. Though quartz is stain-resistant, it's not entirely stain-proof, so it's always best to clean up messes on quartz counters as soon as possible.
- Under normal conditions, quartz is burn-resistant—but it is still best to use a trivet or hot pad underneath any heat-generating devices such as hot pans or crock-pots. Also, be aware that sudden changes in temperature, especially near an edge or cutout, may cause the countertop to crack.
- For tougher cleaning, such as hardened food, dried grease, and other items, you may need to use a plastic putty knife to scrape something off before wiping it down. Don't use an abrasive scouring pad, which could scratch the surface over time. You may also need a mild degreaser to break down hardened grease. Make sure it is labeled safe for quartz surfaces. Don't use cleaning products with bleach in them.

Sources:
Caesarstone: Care Guide
MSI: Care & Use
LG Viatera: Care & Maintenance

*for additional information please contact a professional countertop maintenance company.





UNIQUE STYLES, GREAT QUALITY



 Viatera
Quartz Surfaces
MUSE



Kapal Gallery
3321 W. Expressway 83
McAllen Tx, 78503
956-461-0691

Kapal Supplier
200 W. Expressway 83
Pharr Tx, 78577
956-461-0692

Kapal Stone
2451 E. IH2
Donna Tx, 78537
956-464-3311

Kapal Supplier
2507 E. Expressway 83
Donna Tx, 78537
956-461-0031

 kapal kitchens
 kapalindustries

www.kapalkitchens.com
956-464-3311

February 2023